

# e-Wildcat™ Automatic Drilling System

Version 2.0

Operator Manual

REFERENCE	REFERENCE DESCRIPTION
<p>This document contains proprietary and confidential information which belongs to National Oilwell Varco, hereafter referred to as NOV. It is loaned for limited purposes only and remains the property of NOV. No part of this document may be reproduced or copied in any form, or by any means, including electronic, mechanical, photocopying, recording, or otherwise without the express written consent of NOV. This document is to be returned to NOV upon request and in any event upon completion of the use for which it was loaned. All copyrights pertaining to this document and the information contained and represented are the property of and retained by NOV. Product, brand, or trade names used within this publication are the trademarks of their respective owners.</p> <p>© Copyright 2016 National Oilwell Varco. All Rights Reserved.</p>	<p>National Oilwell Varco            1200 Cypress Creek Road            Cedar Park, Texas 78613            USA            Phone 512-340-5000            Fax 512-340-5219</p>
<p>DOCUMENT NUMBER</p> <p><b>16654800-MAN</b></p>	<p>REV</p> <p><b>02</b></p>





## Revision History

Rev	Date	Reason for issue	Prepared	Checked	Approved
02	06.28.2016	Released per EN#: 1630239	MS	SM/CY	MM
01	06.13.2016	Released per EN#: 1626188	SM	MS	MM

## Change Description

Revision	Change Description
01	First Issue
02	Revision - Document changes to reflect e-Wildcat 2.0 second revision changes

We welcome your suggestions to improve the content of this document. Please email them along with their subject and location in the document to [CPTechPubs@nov.com](mailto:CPTechPubs@nov.com).

Or, simply mark your suggested changes on the specific pages, scan, and email them as attachments.

Alternatively, marked-up pages can be mailed to the following address:

National Oilwell Varco

ATTN: Technical Publications

1200 Cypress Creek Road

Cedar Park, TX 78613

USA



# Table of Contents

## Chapter 1: General Information

<b>Conventions</b> .....	7
Notes, Cautions, and Warnings .....	7
Illustrations .....	7
<b>Safety Requirements</b> .....	8
Personnel Training .....	8
Recommended Tools .....	8
General System Safety Practices .....	8
Replacing Components .....	8
Routine Maintenance .....	9
Proper Use of Equipment .....	9
<b>Product Information</b> .....	9
<b>Related Documents</b> .....	9

## Chapter 2: Overview & Quick Reference

<b>Overview</b> .....	11
Emergency Shutdown/Alarm Indicators .....	11
System Block Diagram .....	12
<b>Quick Reference</b> .....	13
Overview of Operations .....	13
Modes of Operation .....	13
Screens .....	14

## Chapter 3: Operations

<b>Theory of Operations</b> .....	15
<b>Modes of Operation</b> .....	15
Auto Drill .....	16
Time Drill .....	17
<b>Screen Functionality</b> .....	18
Main Driller Screens .....	19
Time Drill Screen .....	19
Auto Drill Screen .....	20
Profile Management Screen .....	21
Profile Guidelines – Canada .....	22
Help Mode Screens .....	22
Auto Drill Help Screen .....	23
Time Drill Help Screen .....	24
Profile Management Help Screen .....	25
Miscellaneous Screens .....	26
<b>e-Wildcat Emergency Shutdown</b> .....	27
Drill Kill Switches .....	27
Dual Quick Disconnect .....	28

# Table of Contents





- e-Wildcat Startup** .....29
  - Powering up the Autodriller .....29
  - Starting the Autodriller .....29
    - Starting in Auto Drill Mode .....29
    - Starting in Time Drill Mode .....30
- e-Wildcat Operational Aids** .....30
  - Reaming .....30
  - Bit Protect .....30
  - Drill Stop Point .....30
  - Pump Pressure Cut Off .....30
- System Setup & Tuning** .....31
  - Control Parameters .....31
  - Parameter Setup .....31
  - Control Response .....32
  - Lift Unit .....32
  - Spring Tension .....32
- RigSense e-Wildcat Channels** .....33
  
- Chapter 4: Troubleshooting**
- Quick Tip Guidelines** .....35

# 1: General Information

This manual contains operations information. Information in this manual should enable qualified personnel to operate this system. Every effort has been made to ensure the accuracy of the information contained herein. National Oilwell Varco (NOV) will not be held liable for errors in this material or for consequences arising from misuse of this material.

## Conventions Notes, Cautions, and Warnings

Notes, cautions, and warnings provide readers with additional information and advise the reader to take specific action to protect personnel from potential injury or lethal conditions. They may also inform the reader of actions necessary to prevent equipment damage. Please pay close attention to these advisories

- Note:**  The note symbol indicates that additional information is provided about the current topics.
- Caution:**  *The caution symbol indicates that potential damage to equipment or injury to personnel exists. Follow instructions explicitly. Extreme care should be taken when performing operations or procedures preceded by this caution symbol.*
- Warning:**  **The warning symbol indicates a definite risk of equipment damage or danger to personnel. Failure to observe and follow proper procedures could result in serious or fatal injury to personnel, significant property loss, or significant equipment damage.**
- ESD Warning:**  **The ESD (Electrostatic Discharge) warning symbol indicates that static control precautions are needed.**

## Illustrations

Illustrations (figures) provide a graphical representation of equipment components or screen snapshots for use in identifying parts or establishing nomenclature, and may or may not be drawn to scale.

For component information specific to your application, see the technical drawings included with your NOV documentation.

## Safety Requirements

NOV equipment is installed and operated in a controlled drilling rig environment involving hazardous situations. Proper maintenance is important for safe and reliable operation. Procedures outlined in NOV manuals are the recommended methods of performing operations and maintenance.



*To avoid injury to personnel or equipment damage, carefully observe requirements outlined in this section.*

## Personnel Training

All personnel performing installation, operations, repair, or maintenance procedures on the equipment, or those in the vicinity of the equipment, should be trained on rig safety, tool operation, and maintenance to ensure their safety.



*Personnel should wear protective gear during installation, maintenance, and certain operations.*

## Recommended Tools

Service operations may require the use of tools designed specifically for the purpose described. NOV recommends that only those tools specified be used when stated. Ensure that personnel and equipment safety are not jeopardized when following service procedures or using tools not specifically recommended by NOV.

## General System Safety Practices

The equipment discussed in this manual may require or contain one or more utilities, such as electrical, hydraulic, pneumatic or cooling water.



*Read and follow the guidelines below before installing equipment or performing maintenance to avoid endangering exposed persons or damaging equipment.*

- Isolate energy sources before beginning work.
- Avoid performing maintenance or repairs while the equipment is in operation.
- Wear proper protective equipment during equipment installation, maintenance, or repair.

## Replacing Components

- Verify that all components (such as cables, hoses, etc.) are tagged and labeled during assembly and disassembly of equipment to ensure correct installment.
- Replace failed or damaged components with genuine NOV parts. Failure to do so could result in equipment damage or injury to personnel.
- Always ensure the unit is de-energized prior to performing any maintenance of component replacement.



## Routine Maintenance

Equipment must be maintained on a routine basis. See the service manual for maintenance recommendations.



*Failure to conduct routine maintenance could result in equipment damage or injury to personnel.*

## Proper Use of Equipment

NOV equipment is designed for specific functions and applications, and should be used only for its intended purpose.

## Product Information

NOV is pleased to introduce the e-Wildcat™ 2.0 automatic drilling system. The following is a list of advanced product features offered by the e-Wildcat system:

- ❑ Fully integrated with the NOV RigSense™ Rigsite Information System.
- ❑ Differential pressure parameter increases downhole motor life and efficiency.
- ❑ Ability to monitor and switch between four control parameters (WOB, ROP, torque and differential pressure).
- ❑ Constant control parameters for WOB or differential pressure.
- ❑ Secondary parameter can be set to respond to abnormal drilling conditions, such as a drilling break and stick-slip.
- ❑ Time drill mode acts as a ROP limiter so operator can preset pace of feed-off during controlled drilling or milling as required.

## Related Documents

For more information, please refer to the following related documents:

- ❑ e-Wildcat™ 1.2 Operator Manual, 42TM81-06
- ❑ e-Wildcat™ 1.0 User Manual, 42TM81-04
- ❑ Wildcat™ ADS Quick Reference Guide, 42TM81-03
- ❑ RigSense™ 3.21 Operator Manual, 42TM64-05 (sales)
- ❑ RigSense™ 3.3 Operator Manual, 42TM64-06 (rental)



## 2: Overview & Quick Reference

This chapter provides an overview and quick reference of the NOV e-Wildcat™ 2.0 stand-alone automatic drilling system.

### Overview

The e-Wildcat (eWC) 2.0 system, an option with RigSense™ 3.21 and later versions, is capable of monitoring up to four drilling parameters at the same time, providing steady-state weight and/or differential pressure (Diff Press) to improve wellbore quality and rate of penetration (ROP). As the weight on bit (WOB) and/or Diff Press decreases during drilling, e-Wildcat pays out the drill line by lifting the drawworks brake handle, allowing the drum to turn. Precise stepper motor control, paired with multiple parameter monitoring, manipulates the brake handle to smoothly control drill line payout. The brake handle is set as the pre-selected set point is reached.

The system is based on Wildcat technology and RigSense surface data for WOB, ROP, torque and Diff Press. Each drilling parameter has its own control set point. The System 10 Data Acquisition Unit (DAQ) performs the control processing as well as data acquisition in one integrated unit which is one of this autodriller's primary advantages. This system is 10 times faster and 16 times more precise than its predecessor.

While providing important cost savings, e-Wildcat capabilities significantly enhance performance while controlling with Diff Press, which has proven to be the superior method of drilling with mud motors. Also, many operators have reduced days on the well by matching precision surface control with sophisticated downhole technology. The ROP limiter allows the operator to preset the feed-off as required for the particular drilling operation, including controlled drilling, reaming, or milling.

The e-Wildcat controller has two main modes or methods of operation: Auto Drill and Time Drill. In the Auto Drill mode, the controller maintains selected drilling parameters at or near their target values. If a parameter begins to approach or exceed its target, that parameter assumes control of drill line payoff. The system turns the parameter in control to a cyan (pale blue) background on the display screen. For the Time Drill mode, the controller maintains drilling at a slow, specific rate (in./min) to address certain specialized operational requirements, like milling a window for sidetrack operations or kicking off directionally. If any of the other active parameters start to exceed their target, they will appear in cyan and drilling will pause until no targets are exceeded.

### Emergency Shutdown/Alarm Indicators

If needed, e-Wildcat can be shutdown in several ways. See "e-Wildcat Emergency Shutdown" on page 27 for more information. e-Wildcat also has a variety of alarms designed to help troubleshoot different components comprising the system. For more information, contact NOV support. Other information for confirming e-Wildcat operation and resolving potential problems or inconsistencies with the system can be found in the chapter titled "Troubleshooting" on page 35.

### System Block Diagram

The following block diagram illustrates the layout of a typical e-Wildcat 2.0 installation.

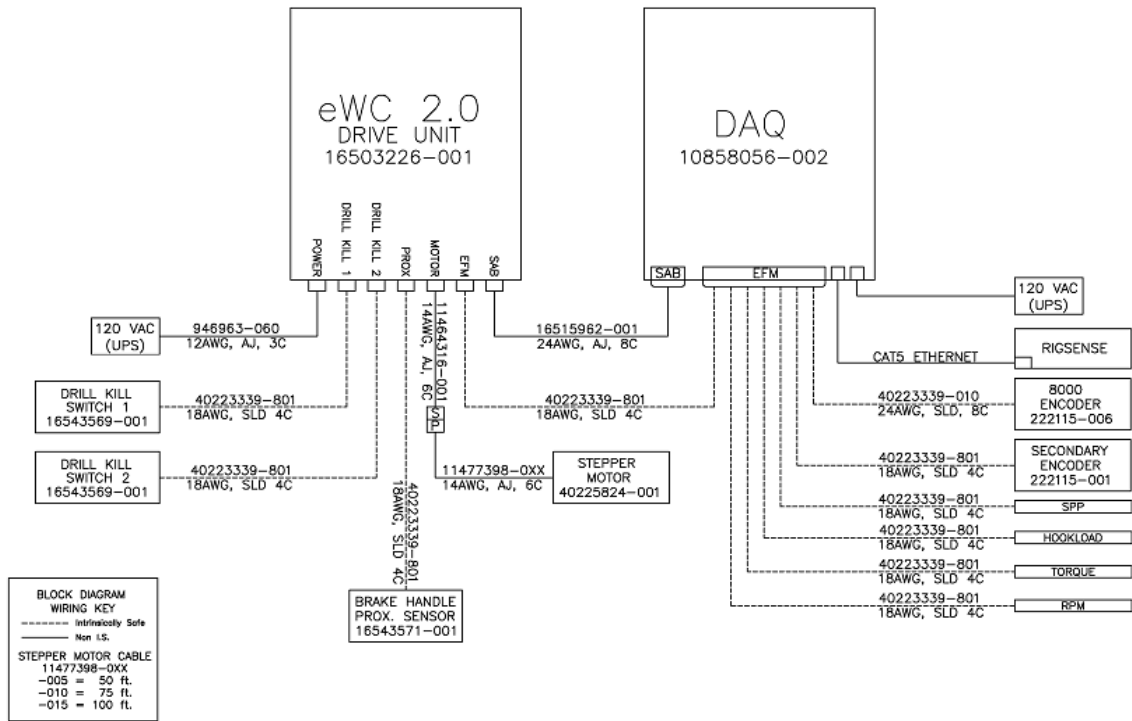

Figure 2.1: Block Diagram, e-Wildcat 2.0

## Quick Reference

This section provides a quick reference regarding e-Wildcat's operations.

### Overview of Operations

**Initialization/General Operation** – In the Auto Drill mode, the e-Wildcat controller maintains selected drilling parameters at or near their target values. If a parameter begins to approach or exceed its target, that parameter assumes control of drill line payoff. The system turns the parameter in control to a cyan background on the RigSense e-Wildcat screen, indicating the parameter currently in control. For example, if the WOB is below its target, the payoff is increased as long as no other parameter (i.e., ROP) exceeds its target. In the Time Drill mode, the controller allows drilling at a slow, specific rate to address the specialized requirements.

To initialize e-Wildcat, set WOB, ROP, Torque and Diff Press targets at the values desired for drilling as dictated by bit parameters and drilling constraints. For example, if the well plan calls for a 20 klb (9 mt) WOB and hole cleaning capabilities for a maximum 300 ft/hr (91 m/hr) ROP, then set the WC Target WOB and WC Target ROP accordingly. Drill line payoff will maintain 20 klb (9 mt) unless it begins to exceed 300 ft/hr (91 m/hr). The same is true for Diff Press and Torque parameters, if enabled.

**Control Response Slide Bar** – Use this bar to adjust control responses with formation changes. The Control Response setting determines how fast the lift motor changes the brake handle in response to parameter changes. If the brake handle begins to oscillate while drilling, decrease the Control Response to smooth out brake control. Conversely, if responses are not rapid enough to prevent parameters from excessively overshooting their targets, then increase it.

**Channel Adjustments/Effects** – After verifying their assignments, channels can be adjusted. For guidelines on these adjustments and their effects on the system, see Chapter 4, titled "Troubleshooting".

### Modes of Operation

Modes	Parameter Set Points	Descriptions
Auto Drill	• WC Target Bit Weight	• Desired weight on bit
	• WC Target Torque	• Desired rotating torque
	• WC Target ROP	• Desired rate of penetration
	• WC Target Diff Press./Pump Press.	• Desired differential pressure (with mud motor) or max. pump pressure (for safety)
Time Drill	• WC Incr Distance	• Desired drill length in specific time period
	• WC Time Interval	• Time period to drill incremental distance
	• WC Len To Drill	• Total desired distance

The annotated screenshots on the next page provide a quick reference to help navigate through the e-Wildcat drilling modes of Auto Drill and Time Drill. Additionally, refer to Chapter 3, titled "Operations" for more information on these operational modes of drilling.

Screens

Displays the current active profile.

e-Wildcat System On (green)/Off (red)

Help(?) provides help text for screen features.

Profiles allow the user to save drilling setpoints for later use

Setpoints

WC Drill Stop Point is the point where drilling stops based on block height

This EZ view displays either: Block Height (on bottom); or WC Ream Speed (off bottom).

Auto Drill screen

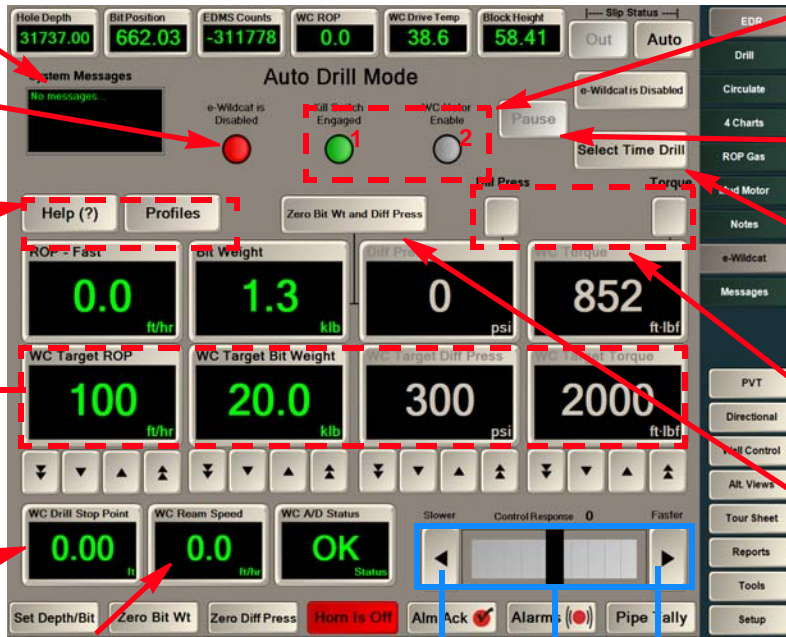

Should be green only if: 1-manual switches are engaged. 2-lift unit is enabled.

Allows a temporary stop paying off the line.

Go to Time Drill; when selected, disables system, so then must be manually enabled.

Enable/Disable DiffPres or Torque buttons

Must zero WOB & Diff Press after each connection with pumps SPM set before tagging bottom.

Decrease control setting (if system is overshooting WOB or other control targets).

Control Response Indicator

Increase control setting (if system is not reacting/keeping up with parameters (drilling below targets)).

System Messages: Provides system information.

Driller sets defined setpoints for:

1-WC Incr Distance: set drilling distance\* for set time interval.

2-WC Time Interval: set time amount in minutes for a specific distance\*.

3-WC Len To Drill: set total drilled distance\*.



If click to disable, then all alarms will clear.

Go to Auto Drill; when selected, disables system, so then must be manually enabled.

Inside adjuster buttons are for small increments; outside buttons are for larger adjustments.

Note: \*Distances are in feet and inches for English units and meters for metric units.

Total Drilled is total length drilled since starting Time Drill.

Note: The On/Off button may remain Enabled and e-Wildcat turned on or off using only the drill kill switch.

## 3: Operations

This chapter provides information on operating the e-Wildcat™ system.

### Theory of Operations

To maintain a steady state drilling condition at the bit, e-Wildcat continuously pays out the drill line by controlling the drawworks brakes with computerized feed-back control of one or more drilling parameters. Parameter options are weight on bit (WOB), rate of penetration (ROP), rotary or top drive torque and differential pressure (Diff Press or Delta P). The system can continuously monitor all four parameters at the same time. The Driller selects the active parameters in the control logic through the touch screen display.

The Driller sets the primary parameter's target value to optimize performance, which is typically WOB when top-drive or rotary drilling, and differential pressure for downhole motor use. ROP or torque can be used as the primary control parameter, but usually they are secondary controls, which improve e-Wildcat's ability to maintain steady-state control when abnormal conditions occur.

Target values for the secondary controls are set as operating limits, similar to alarm limits. Enabled secondary controls run in the background and take over as primary control when their target values, or limits, are reached. The system will recognize which enabled parameter is at its limit as the primary control. To change the primary control drilling parameter, the Driller adjusts to optimize its target value and sets limits for the secondary control parameter. An example of using secondary control is when a drilling break occurs. The ROP secondary control enables a constant speed to be maintained when the ROP limit is reached.

When a hard stringer is encountered, with torque as the secondary control parameter and e-Wildcat's pre-set maximum torque value is exceeded, it will set the brake, allowing the WOB to drill off and the torque to decrease. This prevents the top drive or rotary table from stalling out and reduces the tendency for stick-slip conditions. The primary control parameter will once again takeover when the secondary parameter has stabilized enough to allow the primary parameter's value to be reached before the secondary target value limit.

### Modes of Operation

The e-Wildcat controller uses the following modes (or methods) of operation.

Mode	Description
Auto Drill	Automatic drilling functionality using the following parameters: <ul style="list-style-type: none"><li>• WC Target Bit Weight (desired weight on bit)</li><li>• WC Target Diff Press (desired differential pressure while drilling with a mud motor, or as a safety measure)</li><li>• WC Target Torque (desired rotating torque)</li><li>• WC Target ROP (desired rate of penetration)</li></ul>
Time Drill	Time Drilling functionality using the following parameters: <ul style="list-style-type: none"><li>• Incremental Distance (desired drill length in specified time period, i.e., .05 m)</li><li>• Time Interval (desired time period to drill incremental distance, i.e., 5 min)</li><li>• Length To Drill (total desired distance, i.e., 1 m)</li></ul>

When switching from one drilling mode to another, such as Auto Drill to Time Drill, e-Wildcat must be turned OFF (disengaged). When the system is turned on, the drilling mode of the e-Wildcat is determined by the screen currently viewed. Once e-Wildcat is started in a particular drilling mode, it should remain in that mode. *Turn OFF e-Wildcat to switch from one mode to another.*



*Caution: Turn OFF, or disable, e-Wildcat before switching from one mode to another.*

## Auto Drill

The Main Driller Control screens display values for all the drilling parameters and their target values. The target values can be changed with the large and small increment/decrement buttons immediately below them. Further, as with any EZView push button, the value can be changed by pushing and using the Modify Channel selection. The following bullets discuss each parameter:

- ❑ **Bit Weight (WOB)** – Always enabled as a control of payout of the drill line (like ROP), the WOB control is always enabled. The system will attempt to maintain the target WOB unless another active parameter begins to exceed its target.
- ❑ **Diff Press** – Differential Pressure (Diff Press) is enabled by pressing the Diff Press button located immediately above the Diff Press EZView display. Differential pressure is useful when drilling situations have pump pressure implications such as running a downhole motor or when safety precautions are needed to prevent dry drilling or bit plugging.

Diff Press is enabled as the primary control when there is a downhole mud motor and drilling conditions are more accurately indicated by the change in standpipe pressure than any other parameter. The system will attempt to maintain the target Diff Press unless another active parameter begins to exceed its target set point.

- ❑ **WC Torque** – Excessive drilling torque usually results from downhole conditions like key seat, hole drag or other conditions, and is created by rotating the drill pipe with either a top drive or rotary table when encountering certain conditions. If WC Torque is used with the autodriller, it can help reduce the chance of drilling torque stalling out the rotary table or top drive while drilling.

Pipe torque control inhibits the payoff of the drill line to minimize the high torque fluctuations inherent in drilling hard stringers or ratty formations. When utilized properly, it can help improve the ROP when drilling with PDC bits by holding a steady torque. However, it is not the same as the torque limit settings on top drive or rotary table. Setting WC Target Torque minimizes the number of times the pipe RPM stalls, necessitating the unwinding of the drillstring, lifting off bottom, re-establishing rotation, and tagging bottom to continue drilling. As a result, overall drilling time in these formations is greatly reduced.

- ❑ **ROP Fast** – This parameter is always active, enabled as the control of drill line payout (like WOB). This way, protection is provided in the event a drilling break is encountered. How fast the drill line pays off is limited—even if, for example, the WOB drops off rapidly. This ROP value is basically the maximum speed the travelling block or top drive will descend.



Note: If the autodriller is on and the system senses that the bit is off bottom (bit position is shallower than the hole depth), the pipe will be lowered at the Ream Speed EZView on the e-Wildcat screen. If the ream speed is faster than the target ROP, it will slow to the target ROP as the system senses the bit approaching bottom.



In addition to the drilling parameter indicators and target set points described, there are three EZView channels in the lower half of the screen (for RigSense 3.21 and later versions). Two of the channels (Drill Stop Point and Block Height/Ream Speed) are fixed and cannot be changed or replaced by other channels. The third EZView can be changed according to a Driller's preference. For example, other channels that may be displayed are WC A/D Status, Block Height, and Driller Selectable. Select the EZViews to display and configure like other RigSense channels.

## Time Drill

The Time Drill mode can be used to mill an opening into the side of the casing and to re-enter the hole after a cement plug has been installed. In the milling operation, time drilling allows the milling bit to work slowly at cutting away the sidewall of the casing. As such, this mode is used to allow time for the cutting teeth of the drill bit to negotiate the rapid turn in direction for coming out of the hole milled into the casing.

Time drilling also is used in sidetracking operations for multilateral wellbores. The operation is the same as described previously, except that it takes place in open hole rather than through casing.

The system calculates how far the block should have moved at any given time and turns the lift motor ON if the block is behind pace or OFF if above the pace. The Incremental Distance and Time Interval can be changed once the operation starts and as a situation dictates. If the system is set up to drill one inch every five minutes, it takes small steps to maintain this pace. In other words, it may release the block one fifth of an inch about every minute or so. The system automatically adjusts the payoff to maintain accurate time drilling.

The Driller enters the cutting rate in terms of Incremental Distance (in inches or meters) in a given Time Interval (in minutes) and then indicates the total Length To Drill (in feet or meters). If the WOB goes over its target value, the system slows to zero the incremental payoff until such time as the WOB again falls below the target. Thus, the total time to drill the given length will be lengthened by the time the WOB is exceeded.

The system stops automatically when the Total Drilled read out equals Length To Drill setting, and resets payoff if any parameters change turning Time Drill off. Once set back on, it resets the distance to be drilled.

The Time Drill mode can only be used at speeds less than a given maximum, which is dependent on several factors. For example, the lift motor running continuously without stopping indicates that the desired payoff rate is above the capability of the Time Drill control. Alternatively, one can go to Auto Drill mode, enter the desired rate as the Target ROP (in unit length per time), and then enter a Drill Stop Point value that is below the existing block height by the desired amount to be drilled.

In general, the Time Drill mode should probably not be used if desired penetration rate is more than about 20 ft/hr or about 6 m/hr.

## Screen Functionality

The e-Wildcat parameters display on the RigSense user interface, described in the table below.

Button	Location	Functionality / Purpose
Zero Bit Wt and Diff Press	Top of the both screens, above Bit Weight and Diff Press	Press this button after each connection and just before tagging bottom of the hole to establish the reference point, or baseline, for WOB and/or Diff Press.
Profiles	Top left of Auto Drill screen	Press to modify Profile Management controls from any workstation.
Help (?)	Top left of both drill screens and bottom of profiles dialog	Provides help text when user hovers over displayed question marks.
Select Time Drill (and Auto Drill) toggle button	Top right of both screens, below e-Wildcat button	Toggles to open screen for Time Drill mode and screen for Auto Drill mode.
e-Wildcat is Enabled (and Disabled) toggle button	Top right of both screens, above Select Time/Auto Drill toggle button	Enabled indicates e-Wildcat is ON. Press to Disable and turn e-Wildcat OFF. Note: The state of this button may be left Enabled and e-Wildcat can be turned ON and OFF solely by the drill kill switch or by the auxiliary control box.
Control Response Slide Bar	Auto Drill screen, bottom right side	Slide mechanism to make adjustments while drilling to the response "sensitivity" of the brake handle control. Depending on drilling conditions, the slide bar's up or down movement will aid in finding the optimum control setting or "sweet spot."
Block Height	Lower left of both screens	WC Ream Speed EZ view changes to Block Height when on bottom.
WC Ream Speed	Lower left of both screens	The desired ROP to keep when drill bit is off bottom. WC Ream Speed is enabled only if it's greater than WC Target ROP.
WC Drill Stop Point	Auto Drill screen, lower left	Driller defined distance from drill floor based the position of elevators for the e-Wildcat to automatically stop drilling. Examples: Top Drive typically set at -2 ft when elevators are raised to drill down stand. Kelly rig may be set at +4 ft for elevator height when drilling kelly down.
WC Total Drilled	Time Drill screen, lower left	Displays total length drilled since beginning the Time Drill operation.
WC Incr Distance	Time Drill screen, middle left	Driller defined length of drilling expressed in unit length for a defined time interval during Time Drill (unit length/minute).
WC Time Interval	Time Drill screen, middle left	Driller defined time expressed in minutes for the set incr. distance.
WC Len To Drill	Time Drill screen, middle left	Driller defined set point for total distance to drill during the Time Drill operation.
Pause Button	Top right, near e-Wildcat Enable Button	If engaged, drilling will stop. If disabled, drilling will continue. This is only valid for Auto Drill mode; it's disabled in Time Drill.

## Main Driller Screens

The e-Wildcat screens are accessed in the RigSense user interface. They are similar to other RigSense screens, having the same information on the top and bottom rows. The tabs on the right are available to select various electronic drilling recorder (EDR) screens or that for e-Wildcat. Select the **e-Wildcat** tab to view its screen, of which the touch screen interface contains two main screens. Press the **Select Auto Drill** or **Select Time Drill** toggle button to switch drilling modes.



Note: Like other RigSense screens, the e-Wildcat screens can be configured to display different languages. See the RigSense Manual in "Related Documents" on page 9.

### Time Drill Screen

The following screen is an example of e-Wildcat operating in the Time Drill mode.

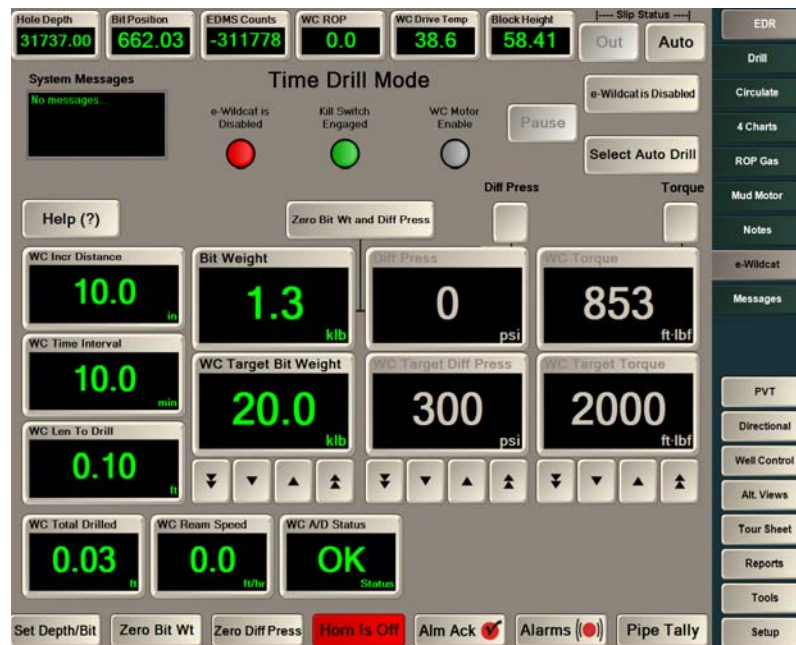

Figure 3.1: Time Drill Screen

For the **Time Drill** screen, above, select the button and set the following drilling parameters:

- **WC Incr Distance** – Enter distance to be drilled for a set Time Interval (in inches or meters).
- **WC Time Interval** – Enter amount of time for the defined Incremental Distance (in minutes).
- **WC Len to Drill** – Enter total distance to drill during Time Drill operations (in feet or meters).

The following features also apply to the Time Drill screen:

**Status Indicators** – Display at the top of the screen. The e-Wildcat button is red when disabled. A green button indicates that e-Wildcat is enabled, as well as when the kill switches and the WC Motor are each engaged. The latter two indicators will be gray when disabled.

**System Messages** – Provides system information. For example, this area provides notifications when a profile has been added, an error has occurred, or if the drill stop point has been reached.

**Help** – Provides help text for e-Wildcat screen EZ views, buttons, and other items.

### Auto Drill Screen

The following screens are examples of e-Wildcat operating in the Auto Drill mode.

The screen below represents the condition in which Diff Press and WC Torque are not active control parameters, shown by grayed-out indicators.



Figure 3.2: Auto Drill Screen - Diff Press and WC Torque Disabled

The screen below represents the condition in which Diff Press and WC Torque are now active control parameters when system is enabled.

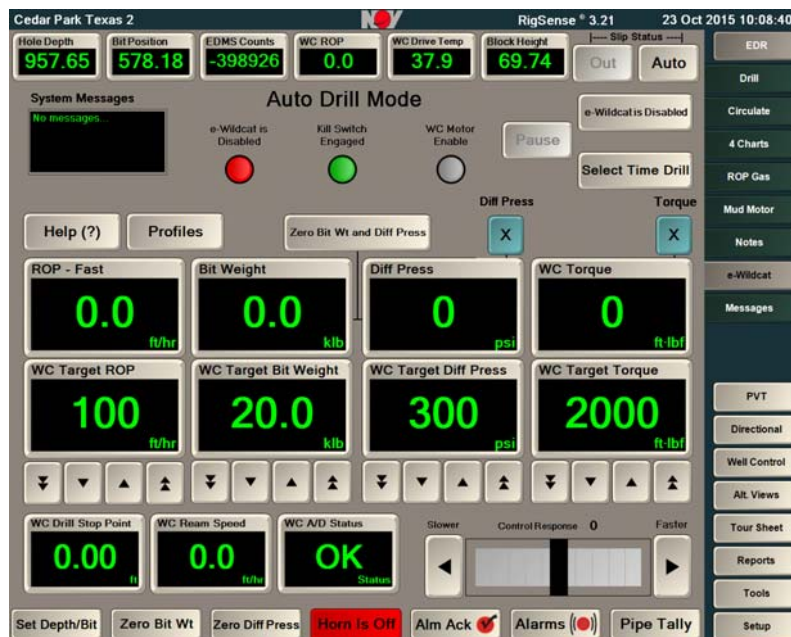

Figure 3.3: Auto Drill Screen - Diff Press and WC Torque Enabled

The following features apply to the Auto Drill screen:

- ❑ **Status Indicators** – Display at the top center. The e-Wildcat button is red when disabled; green when enabled. The WC Kill Switch and WC Motor buttons are also green when engaged.
- ❑ **System Messages** – Provides system information such as notifications when a profile has been added, an error has been detected, or the drill stop point has been reached.
- ❑ **Profiles** – Allows profiles to be created for specific drilling criteria. Refer to the next section.
- ❑ **Control Response** – Displays values in increments of 5, which will snap to the nearest increment when adjusting. For example, a 10 reading will decrease to 5 and increase to 15.
- ❑ **Help** – Provides help text for e-Wildcat screen EZ views, buttons, and other items.

## Profile Management Screen

Click **Profiles** on the Auto Drill screen to access Profile Management controls, shown below.



 Note: See "Profile Guidelines – Canada" on page 22 for Profile information specific to Canada.

**Figure 3.4: Profile Management dialog**

Profiles are stored in RigSense configuration files, and all clients share the same set of profiles. Protection from simultaneous changes at multiple stations is not needed, as the last WINS save will work. Any RigSense station can modify and save a profile. All profile changes must be logged.

Select a **Profile Name** button and enter a name on the keyboard. Select **OK** to keep it, or **Cancel**.



**Figure 3.5: Profiles Keyboard**

Select the **Active** button if the profile is to be active, as shown in the following screen.

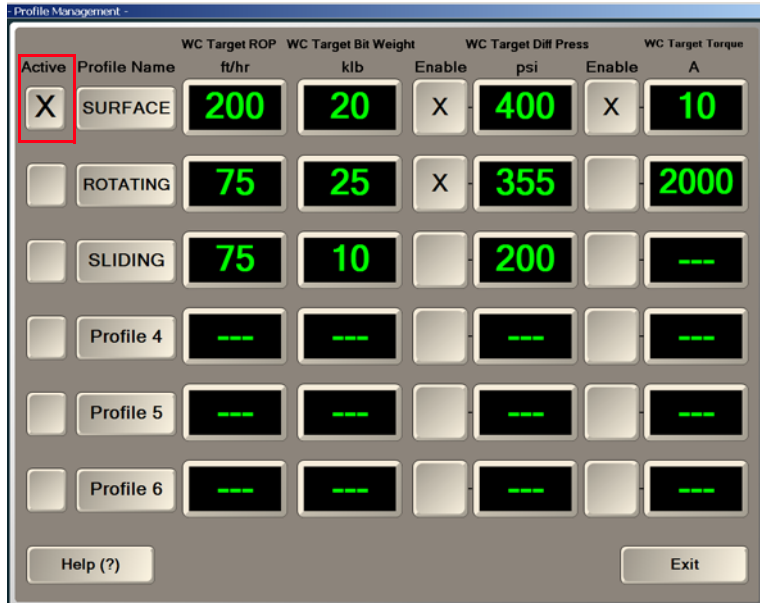

**Figure 3.6: Select a Profile Name**

Select the WC Target Diff Press and/or the WC Target Torque **Enable** buttons to enable these target parameters, if required. Click **Exit** to return to the main e-Wildcat drill screen.

### Profile Guidelines – Canada

For Canada, when Profiles is selected, at least three Profile Names should display: Rotating; Sliding; and Self Adjust. If the Self Adjust profile is not displayed, rename Profile 6 to Self Adjust. Set ROP to 30 m/hr and Set WOB to 10 KdaN. Do not select profiles Diff Press and Torque.

### Help Mode Screens

The e-Wildcat screens include a contextual help mode for the Auto Drill and Time Drill screens as well as the Profile Management dialog, which provide help regarding EZ views, buttons and other items. Help can be accessed using the **Help(?)** button and exited using the **Hide Help** button. The **[F1]** key can also be used to enter the help mode, while the **[Esc]** key can be used to exit it.



- Note 1: User inactivity for 15 sec will cause the system to exit the help mode.
- Note 2: Clicking any tab or button not on the current screen will also cancel the help mode.
- Note 3: Help message languages may be changed within the RigSense user interface.

## Auto Drill Help Screen

Click **Help(?)** to display a grayed overlay covering the screen with visual indicators that offer help.

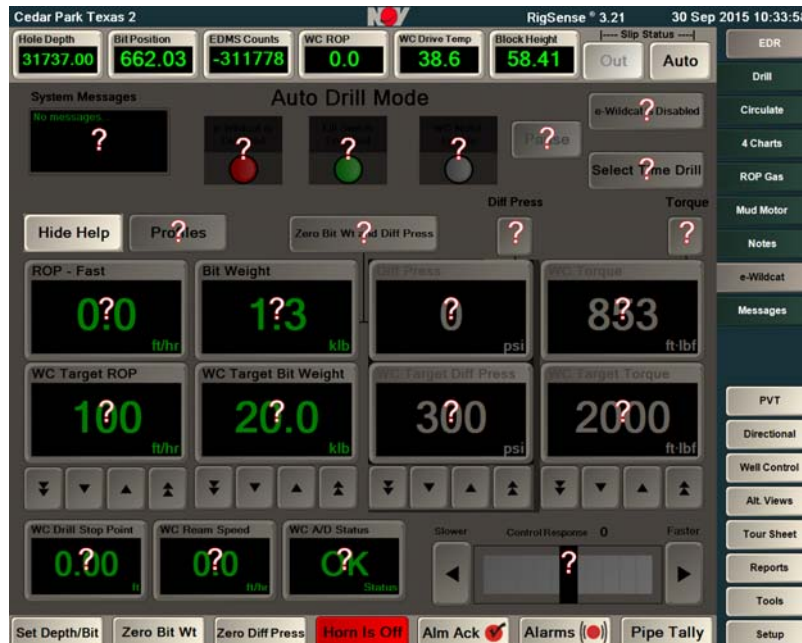

**Figure 3.7: Auto Drill Help Screen**

Hover over a question mark (?) to display a text bubble with the appropriate help text.

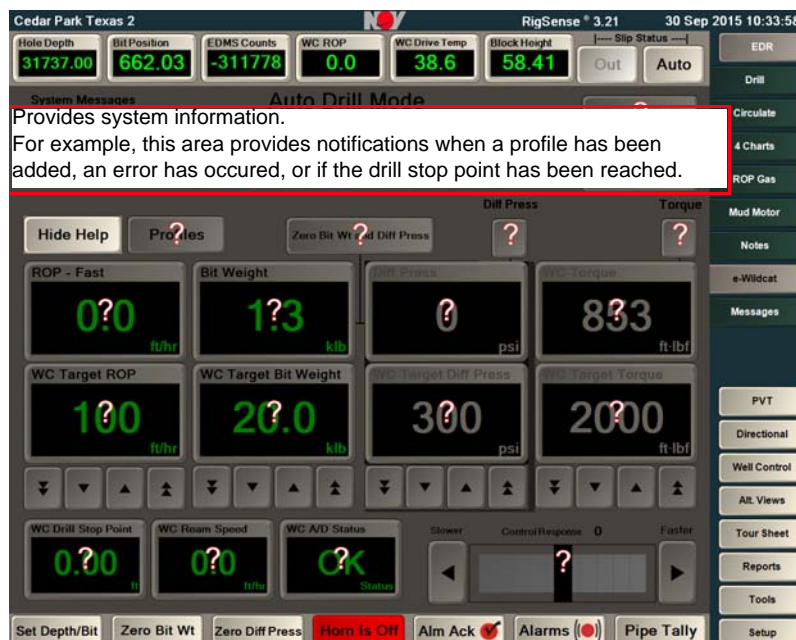

**Figure 3.8: Auto Drill Help Screen with Help Text Bubble**

Click **Hide Help** or [Esc] to exit the help mode and return to the e-Wildcat Auto Drill screen.

### Time Drill Help Screen

Click **Help(?)** to display a grayed overlay covering the screen with visual indicators that offer help.

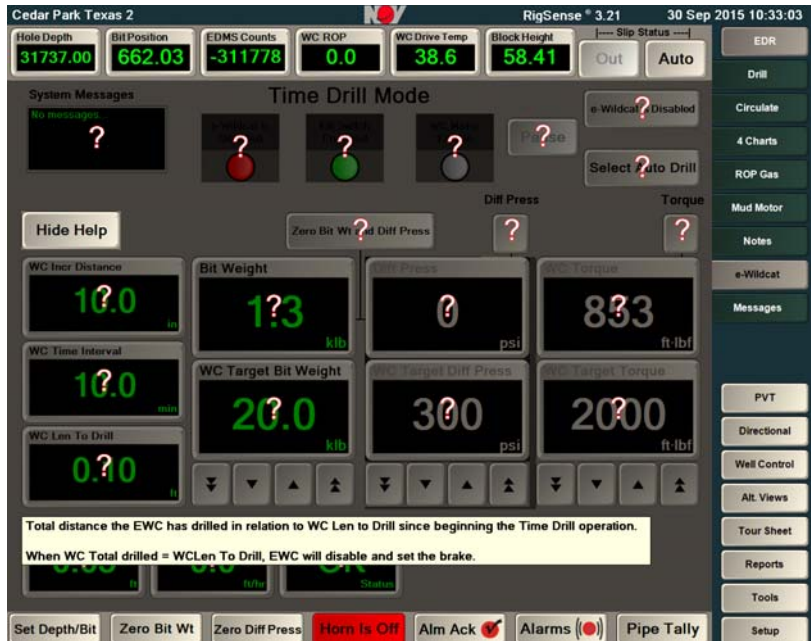

Figure 3.9: Time Drill Help Screen

Hover over a question mark (?) to display a text bubble with the appropriate help text.



Figure 3.10: Time Drill Help Screen with Help Text Bubble

Click **Hide Help** or [Esc] to exit the help mode and return to the e-Wildcat Time Drill screen.



## Profile Management Help Screen

Click **Help(?)** to display a grayed overlay covering the screen with visual indicators that offer help.



**Figure 3.11: Profile Management Help Screen**

Hover over a question mark (?) to display a text bubble with the appropriate help text.

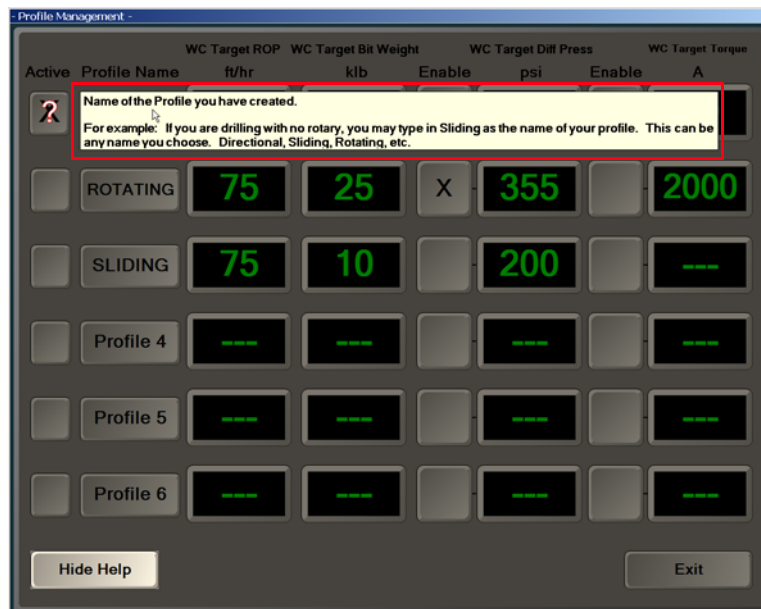

**Figure 3.12: Profile Management Help Screen with Help Text Bubble**

Click **Hide Help** or [Esc] to exit the help mode and return to the Profile Management screen.

## Miscellaneous Screens

The Drill Stop Point on Auto Drill screen must be valid or a warning displays. If it persists, then calibrate Block Height. Detailed calibration steps are provided in the RigSense Operator Manual.



Figure 3.13: Auto Drill Stop Point Warning

The e-Wildcat operation must be disabled when changing operational mode. Click **OK** to disable e-Wildcat and allow a mode change. Verify setup for the mode selected and restart e-Wildcat.

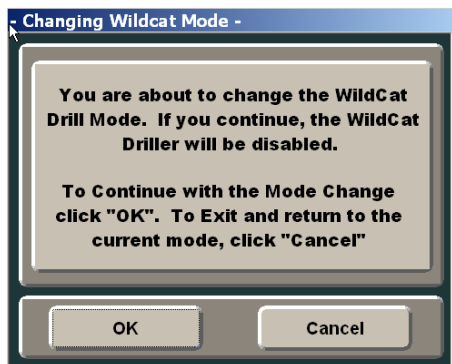

Figure 3.14: Change Mode Alert

Total Drilled resets in Time Drill mode will restart operations based on WC Time Interval and WC Incr Distance values. Click **OK** to continue Time Drilling until WC Total Drilled = WC Len To Drill.

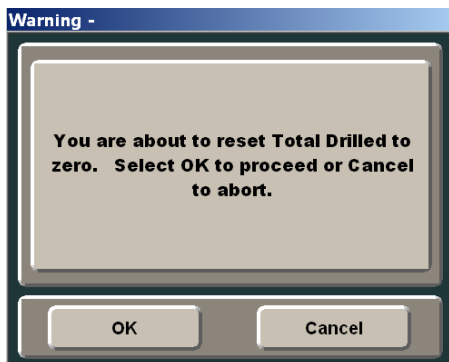

Figure 3.15: Total Drilled Reset Warning

## e-Wildcat Emergency Shutdown

e-Wildcat can be shut down using either its drill kill switches or the dual QD release (page 28).

### Drill Kill Switches

The Drill Kill switches are on-off electrical switches used to engage and disengage the system. They are usually mounted on the drillers console and in the doghouse near the exit to the rig floor.

Push the red button in to disconnect operation independent of the screen's **e-Wildcat is Enabled** button. Otherwise, the Drill Kill button must be out for normal e-Wildcat auto-driller operations.



Figure 3.16: Drill Kill Switch

## Dual Quick Disconnect

The manual Quick Disconnect (QD) provides the Driller with a method of quickly releasing the brake handle in case of mechanical failure and/or excessive payout of the drill line.

Slide hand quickly down toward the manual QD and chain (image on left).



*Caution: Never modify or remove the dual safety quick release for any reason. Always ensure ADS-trained drilling personnel are on or near the brake at all times. Call NOV support if training or service is needed.*



**Figure 3.17: Manual (left) and Auto (right) Quick Disconnect Releases**

The automatic QD release (right image) may also disconnect the lift line should it come in contact with any fixed object or release point. Verify that if the automatic quick disconnect is engaged, the falling cable will not damage additional equipment or personnel.

## e-Wildcat Startup

This section provides instructions to power up and start e-Wildcat in both operational modes.

### Powering up the Autodriller

Perform the following steps to power up the e-Wildcat autodriller:

1. Ensure all connections previously stated in the drive unit and the DAQ are connected.
2. Confirm that the DAQ is turned on.
3. Ensure there are no error conditions/lights.
4. Cycle the e-Wildcat is Disabled/Enabled button in the e-Wildcat screen.
5. Ensure that the WC A/D Status displays **OK**.

### Starting the Autodriller

Ensure that the drillstring is off the slips and the Driller is ready to drill by confirming the mud pump(s) SPM are set, the drillstring is rotating off bottom, the brake handle spring is attached, and the WOB has been zeroed. The e-Wildcat system is now ready to be started for the first time.

### Starting in Auto Drill Mode

Complete the following steps to start e-Wildcat in the Auto Drill mode:

1. Confirm that the drive unit and DAQ are powered on and the WC A/D Status displays **OK**.
2. Connect the lift line to the brake handle.
3. Enter set points for the WC Target Bit Weight, WC Target ROP, and WC Ream Speed. If Diff Press and/or Torque parameters are enabled, similarly set those target values. Verify Control Response is set to 0 (zero).
4. Verify both drill kill switches are released. If the unit has been turned off at either of the drill kill switches, rotate the e-Stop switch clockwise (right) to release the switch.
5. If the system does not begin to work, check to see if the button on the top right corner of the e-Wildcat screen is labeled **e-WC is Disabled**, then press the button once to activate (enable) the system. The button label will change to read **e-WC is Enabled**.



Note 1: Ensure all e-Wildcat on/off controls are **On** or **Engaged** for the autodriller to operate; i.e. the drill kill switches and the touch screen e-WC is Enabled indicator button.

Note 2: Also, ensure that the WC A/D Status displays **OK** since the e-Wildcat will not engage with critical fault codes as described on page 15.

6. Increase the Target ROP until the lift unit responds and begins to lift the brake. Target ROP will vary according to the formation.
7. There are three limiting parameters to monitor during drilling operations: WC Target Bit Weight, WC Target Diff Press, and WC Target Torque.

The e-Wildcat can be stopped or disengaged by the following two actions:

- Press the **e-Wildcat is Enabled** button on the RigSense e-Wildcat screen.
- Pushing the red drill kill switches.

## Starting in Time Drill Mode

Complete the following steps to start e-Wildcat in the Time Drill mode:

1. Confirm that the drive unit and DAQ are powered on and the WC A/D Status displays **OK**.
2. Press **Set Incremental Dist** to enter the incremental amount of pipe to lower in the well.
3. Press **Set Time Interval** and enter the time intervals to lower each pipe length into the well.
4. Press **Set Length to Drill** and enter the total length to Time Drill where time drilling will stop.
5. Press **Total Drilled** to reset the counter and begin another time drilling session.
6. Engage the lift unit by pulling the drill kill switch out. The Drill Kill Engaged lamp should be lit, indicating the switch status. This lamp will not be lit if either switch is pressed.
7. Verify the Enable/Disable button reads **e-Wildcat is Enabled**.

e-Wildcat will begin a cycle of lowering small pipe increments into the hole until the values for WC Total Drilled and WC Len to Drill are equal. During Time Drill, if the WOB exceeds Target WOB, the payoff stops. The Diff Press and Torque, if enabled, and if the process variable exceeds the target, then the payoff will stop during Time Drill. Again, to disengage the e-Wildcat, push in the drill kill switch button or press the **e-Wildcat is Enabled** button on the screen.

## e-Wildcat Operational Aids

Certain features are available that aid the Driller in e-Wildcat operations.

### Reaming

Often faster than WC Target ROP, reaming sets a maximum block lowering speed if off bottom. When the eWildcat is engaged and the bit is off bottom, the system will attempt to achieve either Ream Speed or Target ROP, whichever is higher.



*Caution: Ensure the system can reach the ream speed before leaving e-Wildcat unattended. A likely cause of not reaching ream speed is the auxiliary brake set too high.*

### Bit Protect

Bit Protect™ automatically slows the block as the bit approaches bottom and arrives at the Target ROP when it just encounters bottom. From this point, the WOB builds at the speed set for the Target ROP. This feature requires drill logic (hole depth and bit tracking) to work correctly.

### Drill Stop Point

The Driller sets to stop drilling at a certain block height. For example with a kelly, the "kelly down" is often at an 8-9 ft (2-3 m) elevator height. Once set, e-Wildcat stops where the height indicates.

### Pump Pressure Cut Off

The current pump pressure is captured if WOB or Diff Press is zeroed. If e-Wildcat is on and pump pressure drops more than 50% below the captured value, line payoff stops until pressure builds up.

## System Setup & Tuning

The e-Wildcat system is designed with a variety of adjustments to allow the Driller to optimize the operation to his particular drilling situation. The following sections describe some of the changes the Driller can make to the system to enable the best operation.

### Control Parameters

There are four parameters that can be used to control the payoff of the drilling line while drilling. Foremost of these are ROP, the rate at which the drill line is paid off, and WOB, the assumed downward pressure of the bit on the formation derived from sensing the diminishment of hookload once on bottom. These two modes cannot be turned off on the e-Wildcat autodriller.

Usually WOB is set for the given bit and formation by the Driller and the maximum ROP is set by the hole cleaning ability of the rig. Frequently, the maximum ROP is reduced so that when a drilling break occurs, the speed of the line does not increase so much that an unacceptable WOB excursion occurs when re-encountering the formation.

If a downhole mud motor is used, then a more accurate indication of the bit/formation interface might be the increase in standpipe pressure observed when the mud motor is engaged with the formation. This is called differential pressure (Diff Press or Delta P). The Driller can easily enable this parameter as a controlling means by selecting the Diff Press checkbox on the e-Wildcat screen. Target Diff Press can be set anytime, either prior to or after enabling the system.

When drilling certain "ratty" formations, drill pipe torque can build up to the point of stalling the pipe rotating equipment. Frequently, this means the Driller has to stop the rotation, slowly release the torque built up in the pipe, lift up off bottom, re-establish rotation, and then engage the formation. This mode allows the Driller to set a torque limit that will inhibit drill line payoff when the pipe begins to torque up, often preventing the stall and subsequent response. This improves the rig's overall operations and ROP.

### Parameter Setup

When initializing e-Wildcat, set the targets for WOB, ROP, Torque and Diff Press at the values desired for drilling according to bit parameters and drilling constraints. For example, the well plan may call for a 20 klb (9 mt) WOB and hole cleaning capabilities limiting the ROP to 300 ft/hr (91 m/hr) maximum. Thus, the WC Target WOB is set at 20 (9 mt) and the WC Target ROP is set to 300 (91 m/hr). The payoff will be carried out to maintain 20 klb (9 mt) unless it begins to exceed 300 ft/hr (91 m/hr). The same will be true for Diff Press and Torque parameters, if enabled.

As far as general operations in the Auto Drill mode, the e-Wildcat controller attempts to maintain selected drilling parameters at or near their target values. If a parameter begins to approach or exceed its target, that parameter assumes control of drill line payoff. The system turns the parameter in control to a pale blue (cyan) background on the screen, clearly indicating what is currently in control. For example, if the WOB is below its target, the payoff increases as long as there is no other parameter (i.e., ROP) over its target.

Once the e-Wildcat autodriller starts, make sure that the system smoothly controls the parameters without excessively exceeding their respective targets set for WOB, ROP, Torque, and Diff Press.

## Control Response

In all control modes, the DAQ calculates a response of the system to changes in the parameters. For example, if drilling along at a constant ROP, and the WOB is at the desired value, the DAQ will keep the desired ROP constant, essentially saying "steady as you go." If the WOB varies a little over or a little under, the DAQ will issue a command that says "slow down a little by gently setting the brake" or "speed up a little by gently releasing the brake" as appropriate. If the WOB varies by more than a small amount, the response will instruct to increase or decrease the brake setting even more. However, there are times when the DAQ response may be too much or too little. Large changes in depth or hole geometry might require an adjustment to the calibrated gains.

Therefore, e-Wildcat has a means by which the Driller can change the sensitivity of the system to parameter changes. This is the Control Response slide bar located to the right of the e-Wildcat screen. This slide bar adjustment is used to adjust the control response resulting from formation changes. The setting determines the lift motor's speed changes in response to parameter changes. Moving the control up will make the system respond stronger to a parameter change, while moving it down will make the system respond in a gentler manner.

As a rule of thumb, the Driller should start with the control response up high, when the system will probably "overshoot" in response to parameter changes, and then bring it down to an acceptable level. In this way, the system should be stable but also responsive to changes.

Another guideline is that if the brake handle begins to oscillate or hunt when drilling, decrease the control response to smooth out the brake control. Conversely, if the response is not fast enough to prevent parameters from overshooting the target values, then increase the control response.

There are no hard and fast rules as to what control response value works best for a particular situation. There are times when the required movement might be counterintuitive. The important thing to realize is that the control is available for the Driller to easily adjust to optimize the autodriller's performance, but that the Driller need not be concerned about using it.

## Lift Unit

The primary reason for using a 10:1 gear stepper motor would be if the brake handle required more than 75 lb of force to lift it.

## Spring Tension

Earlier autodrillers also had motors on their lift units that were not as powerful throughout their entire range as the electric motor used on e-Wildcat. As a result, there was some noticeable interaction between the autodrillers with bare minimal spring tension and considerable spring tension. The e-Wildcat system is able to lift the brake handle relatively independent of the applied spring tension, so while pulling a greater tension will help make setting the brake easier, the relative effect on the overall performance of the autodriller is small. The stepper motor needs the brake set with the bare minimal spring tension.



## RigSense e-Wildcat Channels

The e-Wildcat channels displayed in RigSense are defined as follows:

**WC A/D Status** – The autodriller (AD) status provides an indication of the operational status. This WC A/D Status channel displays **OK** if the DAQ and drive unit is fully operational, and displays multiple error codes (faults) if it is not. If a code is present, contact NOV technical support.

**Bit Weight** – The current weight on bit (WOB) while the autodriller drills the current section.

**WC Drill Stop Point** – This user-defined channel identifies the block height where the autodriller will automatically disengage to stop drilling. Because of the increasing number of top drives within the rig fleet, what was previously known as the kelly down point is now called the drill stop point.

**WC Incr Distance** – The user-defined length of drilling expressed in unit length for a defined time interval during Time Drill.

**WC Len To Drill** – The user-defined set point on total length or distance to drill within the well plan during the Time Drill operation.

**WC Loop In Control** – This channel displays the current PID loop (one of four) that the autodriller uses to control the brake handle: 0 = None; 1 = ROP; 2 = WOB; 3 = Diff Pressure; and 4 = Torque.

**WC Motor Enable** – This channel shows if the stepper motor is enabled to pull the lift line to the brake handle: 0 = not enabled; 100 = enabled. When the stop point shown in channel WC Drill Stop Point is reached, the stepper motor is automatically disabled.

**WC Ream Speed** – The desired ROP to maintain when the drill bit is off bottom.

**Fast ROP** – The speed of the traveling block during autodriller usage.

**WC Control Response** – This setting determines how fast the lift motor changes speed in response to parameter changes. If the brake handle begins to oscillate while drilling, decrease the control response to smooth out brake control. Conversely, if responses are not rapid enough to prevent parameters from excessively overshooting their targets, then increase it.

**WC Target Bit Weight** – The desired WOB the user wants to achieve in the current section.

**WC Target Diff Press** – The desired differential pressure the user wants to achieve while drilling with a mud motor, or as a safety measure. WC Target Diff Pressure is activated only when the Diff Press button is enabled from the e-Wildcat control screen.

**WC Target ROP** – The desired drilling rate to be achieved in the well plan. Similar to the ROP adjustment on the pneumatic autodriller, the Target ROP should be adjusted frequently as drilling conditions change. Generally, the Target ROP value should be double (or triple) the WC ROP value, but also should be tuned as needed for smooth payoff. If there is frequent and aggressive brake handle oscillation, the Target ROP should be lowered. If the Target ROP is too low, then more time is required to reach the target parameters (Bit Weight, Differential Pressure, Torque).

**WC Target Torque** – The desired torque the user wants to achieve in the well plan. WC Target Torque is activated only when the Torque button is enabled from the e-Wildcat control screen.

**WC Time Interval** – The user-defined time amount, expressed in minutes, for the defined incremental distance or length.

**WC Total Drilled** – The desired total distance drilled since beginning the Time Drill operation.

**WC Torque** – The current torque needed to drive the rotary while the autodriller is drilling.

**WC Drive Temp** – The temperature of the STAC6 drive in °C. The shutoff temperature of the drive is +85°C.

**WC ROP** – Instantaneous calculation of the traveling blocks used by NOV personnel for tuning the ROP loop and evaluating the AD performance.

**Top Drive RPM** – The current top drive rotation speed (revolutions per minute).

**WC Drum Engaged** – Drum Engaged means the kill switch is pressed to disable the stepper motor. Drum Not Engaged means the kill switch is released and the stepper motor can be enabled. When the kill switch is disengaged, the RigSense e-Wildcat control screen should show the Kill Switch Engaged button in green. Otherwise, this button should be red.

**WC Bit Weight** – Unfiltered WOB calculation used by NOV personnel for tuning the WOB loop and evaluating the AD performance.

## 4: Troubleshooting

This chapter includes information to confirm that the e-Wildcat™ 2.0 system is operating properly. If it is not, the chapter also provides recommended solutions to potential problems. Additionally, e-Wildcat has alarms designed to help troubleshoot different system components. For more information regarding the alarms or resolving potential issues, contact NOV Support.

### Quick Tip Guidelines

Before troubleshooting, use the following guidelines to ensure that components are working. Inform the Driller before performing this test.



Note: Check that the sensor source parameter WC Sensor Source is correctly selected before reviewing the guidelines below. Wrong selection may cause various abnormal drilling behaviors.

Component	Guidelines
Drawworks Brake	Adjust and set the proper spring tension for drum brakes.
Mode Selection	Determine the operational mode selection: <b>Auto Drill</b> or <b>Time Drill</b> . For more information, see "Modes of Operation" on page 15.
e-Wildcat Status	Confirm e-Wildcat system is correctly functioning with an <b>OK</b> display.
Channel Assignments, Adjustments & Effects	Verify channel assignments and note any deviation from the standard configuration. After configuring, these channels may be adjusted.

